



FinishLynx Scholastic Package

Quick Start Guide

For EtherLynx Vision Cameras



Scholastic - Track

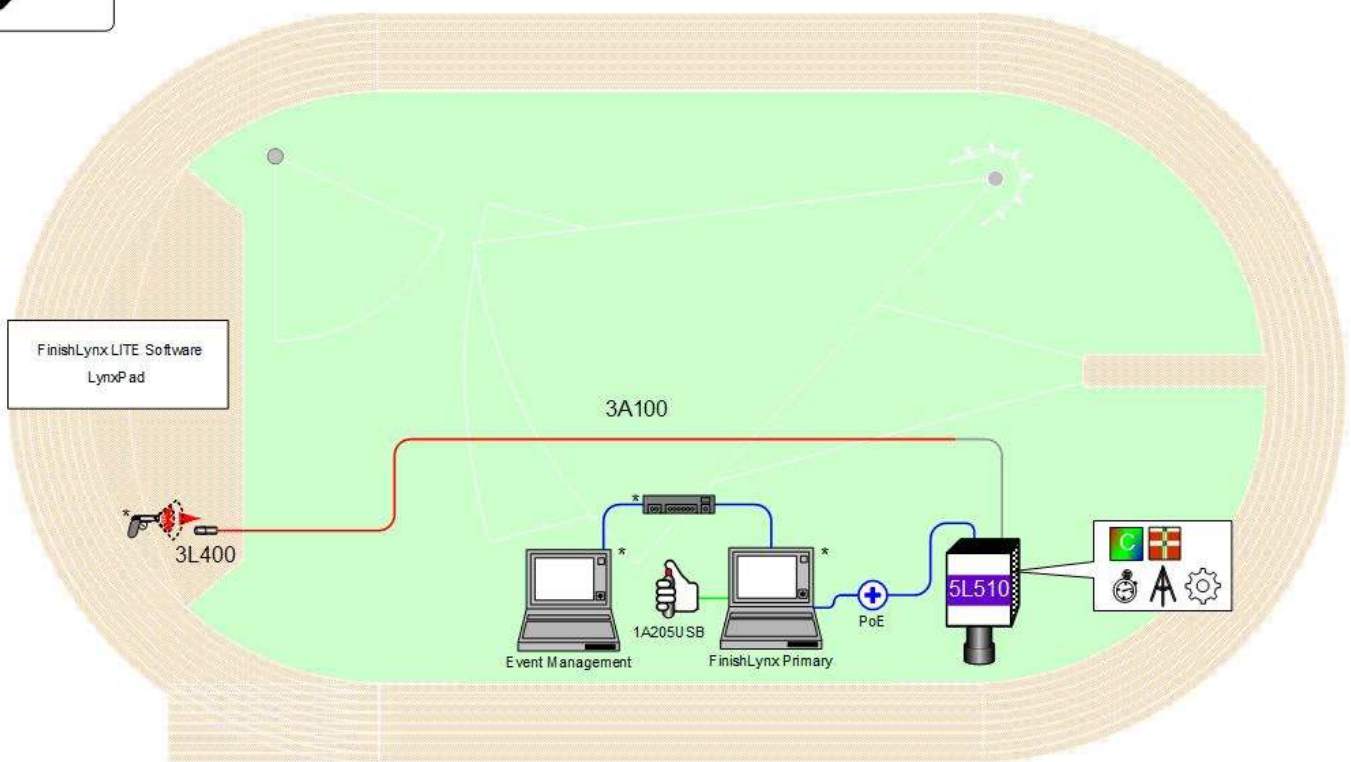

* Computers, Hub, network cable, and starting pistol not included in package

© 1992 – 2024 | Lynx System Developers, Inc. | www.finishlynx.com

Download a copy:



Contact Technical Support:

Email: support@finishlynx.com

Phone: 978-556-978

Join Us Online:

Timer's Group: facebook.com/groups/finishlynx

Facebook: facebook.com/finishlynx

Instagram: [@finishlynx](https://instagram.com/finishlynx)

Verify that your FinishLynx Scholastic System contains the components pictured here. If something is missing, or you have questions regarding your system, call: 1-800-989-LYNX or send an email to support@finishlynx.com.

Item	Description	Part Number	Item	Description	Part Number
	Carrying case	1A210		Normally closed start sensor with light	3L400
	EtherLynx Vision Scholastic high sensitivity camera	5L510		500 ft. start sensor cable	3A100
	CS Mount 2.8-10mm P-Iris Lens	CS2810P		DB15 to XLR Connection cable	451-S
Not pictured	Scholastic-level Timer enable option embedded in camera	5LTE		25 ft. Ethernet cables (x2)	C10BT-25
	Geared head	BG3275		Capture button	1A205USB
	Camera tripod	5LTP10		Power Injector for Power Over Ethernet	IDL-PoE
	Lynx USB Flash Drive with FinishLynx LITE & LynxPad	5LSWL and 9LSW01			

Be sure to keep your USB flash drive safe. It includes your Serial Numbers, Software, & Quick-Start Guides. To access the files, insert the flash drive in your computer and navigate to the folders.

Items Not Included

- Computer (laptop recommended) running Microsoft Windows. Your computer needs: one available USB port and one available Ethernet port.
- Plumb bob and string. The plumb bob is available at your local hardware store, and you can use virtually any type of string or twine, as long as it is at least the width of your track (optional).
- Printer (optional).

Introduction

In this quick start guide, you will learn how to set up and configure the FinishLynx LITE network, set up the EtherLynx Scholastic camera and align it with the finish line using the EasyAlign software feature. You will also learn how to capture, evaluate, and print a FinishLynx LITE image and results, and import a start list created in LynxPad.

For more detailed or advanced instructions, consult the online *FinishLynx Operator's Manual* (help.finishlynx.com) or the technical support section of our website: www.finishlynx.com/support/.

Step 1. Go to the Track

Bring your FinishLynx system (and an assistant) to the track. Make sure there is **power** available for your computers and for the power injector. The EtherLynx Vision camera will receive power via the Ethernet data cables.

Set up a table near the finish line, ideally on the infield if power is available. The finish line should have black lane markers painted or taped on the finish. If not, we suggest you use black matte tape to designate lane lines. This will help you align the camera and get clearer images.



Step 2. Install the Software

A. FinishLynx LITE (Scholastic Package)

Install **FinishLynx LITE** from the USB flash drive provided with your system or download the latest version at: www.finishlynx.com/product/software/finishlynx-results-software/

When prompted, enter the serial number(s) provided on the flash drive. Please note that your **FinishLynx LITE** serial number will **not** work with the regular version of FinishLynx.

B. LynxPad

Install using the Lynx flash drive or download the latest version of LynxPad at:

www.finishlynx.com/product/event-management/lynxpad/

Follow the instructions on your screen to install LynxPad. When prompted, enter the serial number found inside the Lynx flash drive.

Note: You should **Right-Click** on the installer and select **Run as Administrator** to install LynxPad, if you do not, you will not be able to print from LynxPad.

Step 3. Evaluate a Sample Image

1. Start FinishLynx LITE. Click **File | Open....**
 2. Double-click **Sprint.evn** to open the sample event.
- Note:** This sample is a two-camera image. Your Scholastic System uses only one line-scan camera and produces single-camera images.
3. Click the mouse once on the torso of a competitor on the left side of the screen. A red hairline appears. You can click and hold the red crosshair and drag it up or down to the correct lane number on the left side of your screen.

4. Press the **Enter** key on your computer. The finisher's time appears in the start list above the image.
5. Repeat these steps for all the competitors on the screen. You have just successfully evaluated a race in FinishLynx.
6. Click **File | Close window**. If you want to reuse the image later for practice evaluation, click **No** when asked to save your changes. Close FinishLynx.

Step 4. Configure the network for Windows 10 & 11

1. Go to the windows **Control Panel**. On the top right is **View By** with a drop-down arrow. Click the drop-down arrow and choose Small or Large Icons.
2. Find and double click on **Network and Sharing Center**. They are listed alphabetically by icon name.
3. This will open the **Network and Sharing Center**. On the left is a blue section titled Control Panel Home.
4. Click on the **Change Adapter Settings** icon.
5. A new window will open displaying your network connections. Right click on the **Wireless Network Connection** and select **Disable** from the list of items. This is only recommended for the FinishLynx Capture computer.
6. Right click on the **Local Area Connection** and select **Properties** from the list of items. A new window will appear with a list of connection items. Click to select **Internet Protocol Version 4 (TCP/IPv4)** and click the **Properties** button.
7. A Properties window will appear and is typically set to **Obtain an IP address automatically**. Click to select the radio button for **Use the following IP address**. In the box for IP address, enter 192.168.0.5 for FinishLynx and hit **Tab** key to auto fill in Subnet mask 255.255.255.0
8. Click OK and navigate back to the Control Panel. In the control panel click on the Windows Firewall icon. Under Control Panel Home, on the left, click on **Turn Windows Firewall on or off**.
9. Turn off both Home and Public Firewalls (Domain for Windows Pro).

NOTE – Repeat the same steps on the LynxPad computer entering a different IP address (e.g. recommended 192.168.0.90)

Step 5. Set up the EtherLynx Scholastic Camera and Tripod

Note: In addition to following the instructions in this quick start guide, we recommend you view the *Camera Setup, Mounting*, and

Alignment videos available on the Lynx YouTube channel and website: www.finishlynx.com/support/setup-videos/

1. Open the legs of the tripod in line with the finish line, preferably on the infield and approximately 8-10 feet back.
2. Extend the legs of the tripod so they are at full height – approximately 6 feet.
3. Attach the supplied 1/4" to 3/8" brass adaptor to the screwed stud on top of the tripod (Adaptor is taped to adjustment handle of tripod)
4. Secure the geared head to the stud on top of the tripod.



5. Note how the mounting plate is attached to the geared head. Then, pull back on the lever at the top of the geared head to release the mounting plate.
6. Using the hole closest to the camera lens on the bottom of the camera, tighten the mounting plate by screwing it into place. The arrow on the bottom of the mounting plate should point toward the lens. Use a flathead screwdriver or a coin to tighten the mounting plate.
7. Make minor adjustments to the tripod legs so both bubbles on the tripod are centered.

Step 6. Align Camera on Finish Line

1. On the near side of the finish line, hold the plumb bob so that it is suspended directly above the middle of the finish line. This is the **plumb line**, shown as **a** in the image below.
2. Tie string to the screw on the top of the tripod head. Have your assistant take the other end of the string to the far side of the finish line and hold the string taut. This is the **sight line**, shown as **b** in the image below.
3. Move the tripod to the left or right until the plumb line and sight line touch at position **c** in the image below. The camera is now in the finish line plane.
4. Attach the camera to the tripod by clicking the mounting plate in place on top of the geared head. The lens should point toward the finish line.
5. Turn the black knob on the geared head that controls the **tilt** of the camera so that it is at about a 30-degree angle to the ground.

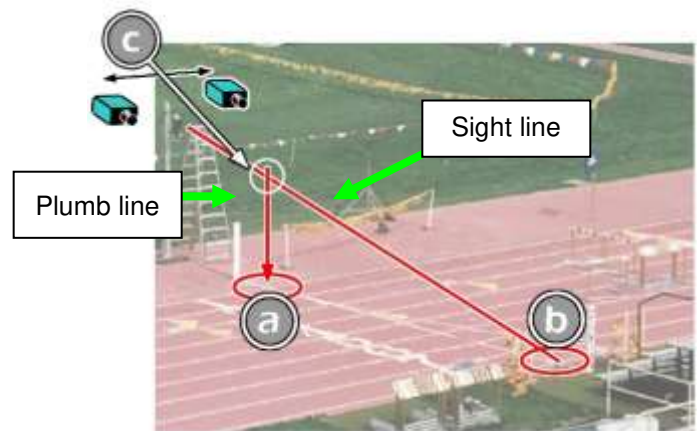

Step 7. Connect the Cables

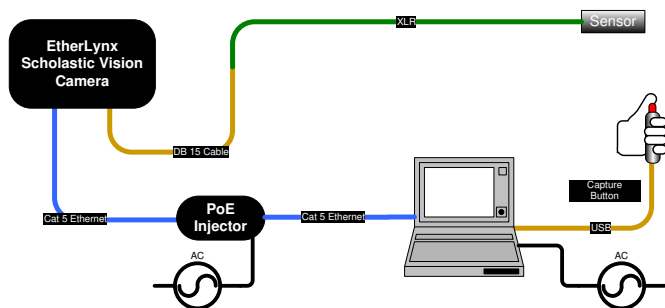

5. Turn on the camera by pressing and holding the black power button on the back.



1. Connect an Ethernet cable between the back of the camera labeled **POE 10/100/1000** to the port labeled **Out** on the Power over Ethernet injector.
2. Connect an Ethernet cable to the network connection on your computer and the other end to a port labeled **In** on the Power-over-Ethernet injector.
3. Connect the male end of the start sensor cable to the DB15 to XLR Connection cable. Attach the start sensor to the other end of the cable and keep the start sensor close by.
4. Connect the capture button cable to a USB port on your computer.

Step 8. Align the EtherLynx Camera

Note: The EtherLynx Vision camera can be aligned using either 1-D mode or 2-D EasyAlign mode. We recommend using EasyAlign. If you are using an older model EtherLynx camera, however, it must be aligned using classic 1-D mode.

NOTE: If running a wireless Ethernet card on your computer, we recommend that you disable it while the camera is booting.

Start FinishLynx LITE. Wait while the green status bar in the lower right corner of the screen completes its cycle.

Align Vision Camera in EasyAlign 2-D Video Mode

1. **Activate EasyAlign** by clicking on the 2D align icon  in the top left-hand corner of the FinishLynx **Hardware Control** screen.

The icon turns green  and the 2-D video viewer appears within the software. The 2-D viewer makes it easy to see how your camera is aligned on the finish. **The goal is to align the green vertical line with the painted finish line and near its front edge.**

2. **Adjust Camera Orientation**

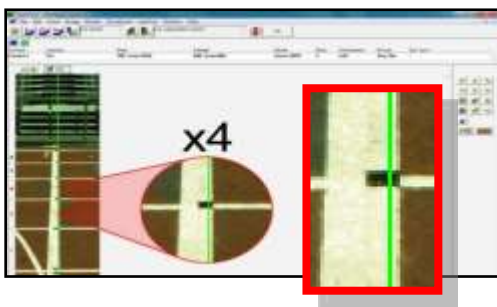

Use the tripod's **Tilt**, **Pan**, and **Swivel** knobs to adjust the camera orientation of the camera on the finish. You want to ensure that the green vertical line is perfectly aligned on the white finish line and that all lanes are visible in the viewer.

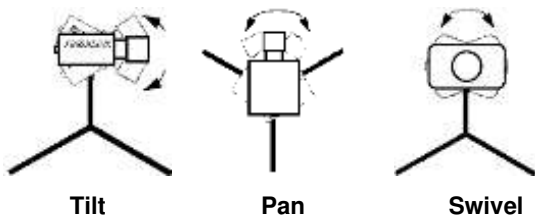

Have your assistant run through the finish line and watch where he/she appears on the computer monitor. The goal is for the runner's torso to be fully visible in both the inside and outside lanes. Once the camera position is correct, you can then optimize the remote lens settings.

3. **Adjust & Optimize Lens Settings**



First, connect the lens cable to the Remote port on the back of the camera.

Then, configure your camera settings to use the 2.8-10mm P-Iris lens: in FinishLynx, access the camera settings by clicking





Under the Setup tab, locate the **Iris Type:** setting and select the *P-Iris* radio button.

Click **Ok**.



Manually adjust lens focus and zoom rings. This lens is a *varifocal* lens, meaning it will not stay in focus when you change the zoom. This step will require some fine tuning to get the proper zoom and focus to achieve a good image.

4. Once the camera appears to be aligned, click the green alignment  icon to close 2D alignment and then click on the red 1-D alignment icon . You will know when your camera is aligned on the finish line because the 1-D image will be primarily white. See image below for proper 1-D alignment.

If you followed the steps closely in 2-D align, the camera should already be aligned in 1-D mode as well. The 1-D image should look like the following screen capture:

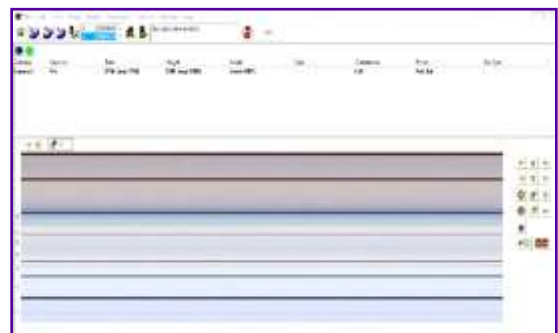

5. Have your assistant run through the finish line and watch where they appear on the computer monitor. The goal is for the runner's torso to be fully visible in both the inside and outside lanes. Now, have your assistant run through the inner-most and outer-most lanes. Adjust the **tilt** of the camera until they are clearly visible on both ends of the finish line. **Note:** It may be necessary to move the camera further back from the track if you cannot see all lanes in the image.

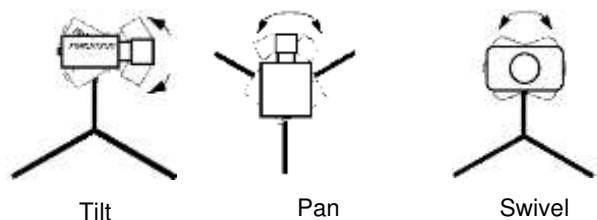

6. After the image on the computer shows a white background and black lane lines and your assistant appears in the inner and outer-most lanes, adjust the camera lens focus ring again until all lanes appear crisp and in focus

Step 9. Adjust FinishLynx Camera Settings

1. Click  | **Parameters** | **AGC**.
2. Click the **Setup** tab and enter the number of lanes at your finish line in the **Lanes** field.
3. Check that **Identify by...** is set to **Lanes**
4. Click **Ok**.
5. Select **File** | **Options** from the FinishLynx Lite menu bar
6. Under the **General** tab select the correct USB/Serial Port from the **Capture Button** drop down listing.

Step 10. Create a Shared Directory for FinishLynx and LynxPad

1. Right-click on your computer desktop and select **New** | **Folder**. When the **New Folder** appears, change the name to **Practice competition**.
2. In FinishLynx, click **File** | **Options....** Click the **Browse** button on the **Event Directory:** and navigate to the **Practice competition** directory you just created.
3. Still in FinishLynx, click the **Database** tab. Click the **Browse...** button next to the **Output Directory:** and navigate to the **Practice competition** directory. Then, click **Ok**.
4. Now, start LynxPad by clicking the Windows **Start** button and then **LynxPad**.
5. Click **File** | **Options...** and **uncheck** the **Load Existing Results on Program Start** box. Then, click **Ok**.
6. Open the sample competition by clicking **File** | **Open**. Navigate to **C:\LynxPadData\Sample** and then double-click the **lynx.cmp** file. A practice competition opens on the screen.
7. Still in LynxPad, click **File** | **Options....** Click the **Browse** button next to the **Directory:** text field. Navigate to the **Practice competition** file you created earlier. Select it and click **Ok**. Click **Apply** and then click **Ok** again.
8. Still in LynxPad, click **File** | **Save as...** and navigate to the **Practice competition** folder. Then, click **Ok**. Now, FinishLynx can get start lists created in LynxPad, and LynxPad can import results generated by FinishLynx.

Step 11. Use FinishLynx with LynxPad Data

1. In FinishLynx, click  to load the schedule of events from LynxPad. The **Go To Event** dialog appears.
2. Click the **Load Schedule** button once. Click the drop-down list under the **Load Schedule** button. A list of events appears. Click to select the **"110 Meter Hurdles Men (9, 3, 1)"** event in the list, and then click **Ok**. The first heat of the third round of the men's 110m hurdles opens on the FinishLynx screen.
3. Either use a starting gun, or knock the sensor sharply against a hard object - this simulates the firing of the starting gun and starts the yellow FinishLynx timer.

The image shows a close-up of the FinishLynx software interface. A red rectangular box highlights a yellow button with a starting gun icon, which is used to capture the race start. The button is labeled 'Starting'.
4. Have your assistant run through the finish line while you press down and hold the red capture button to capture the image. Release the button as soon as he/she has run completely through the finish line.
5. Practice evaluating the image by following the same steps you followed earlier in Step 3
6. Click **File** | **Save** to save the race to the **Practice competition** directory.
7. Crop space between competitors in your FinishLynx image by right-clicking and drawing a box around the unwanted space. Release the mouse button and select **Crop** from the dialog that appears.
8. **(Optional)** Print the results and a portion of the FinishLynx image by right-clicking on the image and drawing a box around the portion you want to appear in your printout. For example, the first place finisher or a close finish between two competitors. Click **Ok** and then select the printer from the **Print** dialog to print the image and results.
9. Click **File** | **Close window** and then click **Yes** to save changes you made to the FinishLynx image when you cropped it.
10. In LynxPad, click to highlight **Men 110 Meter Hurdles** in the **Events** window. The start list appears in the **Heats** window.
11. Still in LynxPad, click **Competition** | **Refresh All Results**. The results from the race you just evaluated appear in LynxPad.

Notes: