

EtherLynx Vision PRO X Cameras

Quick Start Guide



Download a copy:



Contact Technical Support:

Email: support@finishlynx.com

Phone: 978-556-978

Join Us Online:

Timer's Group: [facebook.com/groups/finishlynx](https://www.facebook.com/groups/finishlynx)

Facebook: [facebook.com/finishlynx](https://www.facebook.com/finishlynx)

Instagram: [@finishlynx](https://www.instagram.com/finishlynx)

Please verify that your FinishLynx Package contains all the components pictured here. If something is missing, or if you have questions about setting up your system after following this quick start guide, call: 1-800-989-5969. For additional tech support documents and downloads, visit www.finishlynx.com/support/

Item	Description	Part #	Item	Description	Part #
	EtherLynx Vision PRO X (lens not included)	5L700F		Remote Iris cable	MV-RF
	DB15 to XLR Connection cable	451-S		Internal GPS Antenna	N/A
	Power Injector for Power-over-Ethernet	IDL-PoE		Wireless EVF dongle (see camera back)	N/A
	25 ft. Ethernet cables (x2)	C10BT-25		Rain Guard	5L300RG

Optional Items shown below: **(not included)**

	Geared Head	BG3275		F-Mount Lens	F###.#
	Camera Tripod	BG3036		Capture button	1A205USB
	Super Head Clamp	BG2909		Carrying Case	1A207
	Remote positioner	2L102		Lynx USB Flash Drive with FinishLynx32	5LSW

Be sure to keep your USB flash drive safe. It includes your Serial Numbers, Software, & Quick-Start Guides. To access the files, insert the flash drive in your computer and click on [START.html](#).

Items Not Included

- **Windows PC** - Your computer needs: 1 available USB port and 1 available Gigabit Ethernet port.
- **Gigabit Network Switch** (optional)

Introduction

In this QSG, you will learn how to configure the FinishLynx network, set up the **EtherLynx Vision PRO X** camera and align it with the finish line using the EasyAlign software feature.

For more detailed or advanced instructions, consult the online *FinishLynx Operator's Manual* (help.finishlynx.com) or the technical support section of our website: www.finishlynx.com/support/.

Step 1. Install the Software

1. Install FinishLynx from the USB provided with your system or download the latest version at: www.finishlynx.com/product/software/finishlynx-results-software/
2. Follow the instructions to install **FinishLynx**. When prompted, enter the serial numbers provided on the flash drive.
3. Start FinishLynx by clicking the Windows **Start** button and selecting **FinishLynx**.

Step 2. Configure the Network for Windows

1. Go to the windows **Control Panel**. On the top right is **View By** with a drop-down arrow. Click the drop-down arrow and choose Small or Large Icons.
2. Double-click **Network and Sharing Center**. They are listed alphabetically by icon name.
3. On the left is a blue section titled Control Panel Home. Click the **Change Adapter Settings** icon.
4. Right-click on **Local Area Connection** and select **Properties** from the list. A new window will appear with a list of connection items. Select **Internet Protocol Version 4 (TCP/IPv4)** and click the **Properties** button.
5. A Properties window will appear and is typically set to **Obtain an IP address automatically**. Select the radio button for **Use the following IP address**. In the box for IP address, enter 192.168.0.5 for FinishLynx and hit **Tab** key to auto fill in Subnet mask 255.255.255.0
6. Click **OK** and navigate back to the Control Panel. In the control panel click the Windows Firewall icon. Under Control Panel Home, on the left, click **Turn Windows Firewall on or off**.
7. Turn off both Home and Public Firewalls (Domain for Windows Pro).

Step 3. Attach the Camera to the Tripod or Clamp

1. Secure the geared head to the top of the tripod or clamp and adjust to center the level bubble.
2. Pull back on the lever at the top of the geared head to release the mounting plate.
3. Tighten the mounting plate to the bottom of the camera by turning the screw with a flathead screwdriver.
4. Attach the camera on the geared head by clicking the mounting plate into place.
5. Turn the black knob on the geared head that controls the **tilt** of the camera so that it is angled down about 2/3rd of the way up the finish line.

Step 4. Connect the Cables

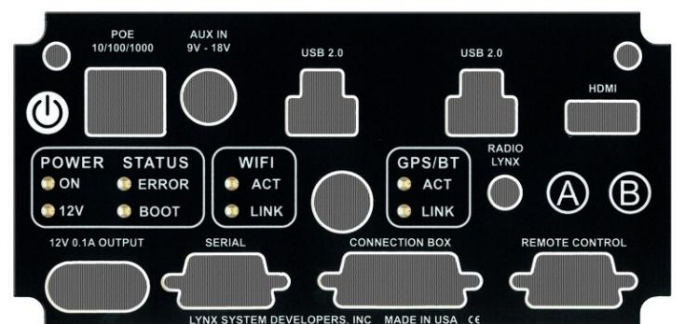
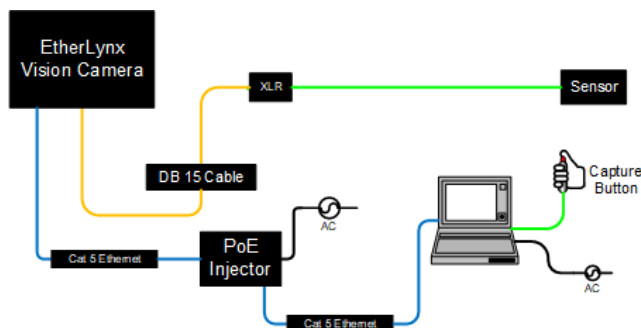

1. Connect an Ethernet cable between the back of the camera labeled **POE 10/100/1000** to the port labelled **Out** on the Power-over-Ethernet injector.
2. Connect an Ethernet cable to the network connection on your computer and the other end to a port labelled **In** on the Power-over-Ethernet injector.
3. Connect DB15 to XLR Connection cable to the port on the back of the camera labeled **Connection Box**.
4. Connect the male end of the start sensor cable to the DB15 to XLR Connection cable. Attach the start sensor to the other end of the cable.
5. Connect the capture button to a USB port on your computer.

Step 5. Align the EtherLynx Camera

1. **Start FinishLynx.** Wait while the green status bar in the lower right corner of the screen completes its cycle.
2. **Activate EasyAlign** by clicking on the 2-D Align Icon  in the top left-hand corner of the FinishLynx **Hardware Control** screen.

The icon turns green  and the 2-D video viewer appears within the software. The 2-D viewer makes it easy to see how your camera is aligned with the finish. **The goal is to align the green vertical line with the finish line and near its front edge.**

To use the **Wireless Electronic ViewFinder (EVF)** on your mobile device:

- a. Check the **EVF** box.
 - b. Go to the Wi-Fi settings on your phone:
 - Connect to the camera's wireless network: **5L700_[SN]**
 - Confirm connection, even without an internet connection.
 - c. Open a web-browser on your mobile device.
 - d. Go to **192.168.4.1:8080**
3. **Adjust Camera Orientation**

Use the geared heads **Tilt**, **Pan**, and **Swivel** knobs to adjust the orientation of the camera on the finish. You want to ensure the green vertical line is perfectly

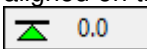
aligned on the finish line, that the level indicator reads  and that all lanes are visible.

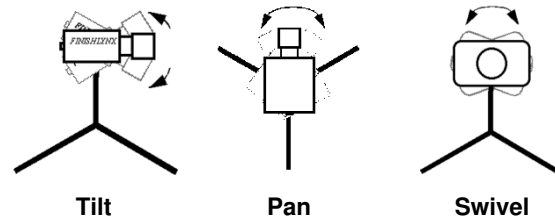

4. **Adjust Zoom**

Adjust the zoom of the lens to view the entire track and enough above the far side to capture the entire object.

5. **Adjust Focus**

- a. Check the **AEC** box and open the lens iris completely.
- b. Adjust the focus while checking the focus helper . Find the highest possible value.
- c. Uncheck the **AEC** box.

6. **Set White Balance**

- a. Right-click and draw a box around a small amount of the white image.
- b. Click . White balance is now set.

Step 6. Adjust the Camera Settings

1. Click **Camera Settings Icon**  to open the Camera Settings dialog.
2. Select the **Setup** tab:
 - a. **Image Orientation:** Select the correct orientation for finish (infield would be Left orientation)
 - b. **Identify By:** Select Lane or ID.
3. Click **OK** to close the **Camera Settings** and it is advised to restart the FinishLynx software.

PRO TIP Best Practice

1. **Zoom** in as much as possible to fill the field of view. Avoid dead space at the top or bottom.
2. Use **LuxBoost** to keep the **Gain** value as low as possible to reduce the image noise.
3. Adjust the **Frame Rate** to match the speed of the object.

Looking for more resources? Visit our [YouTube Channel](http://www.youtube.com/finishlynx) (www.youtube.com/finishlynx) for setup and support videos.